



UNIVERSITY OF
WATERLOO

CS 456/656

Computer Networks

Lecture 11: Network Layer – Part 3

Mina Tahmasbi Arashloo and Bo Sun

Fall 2024

A note on the slides

Adapted from the slides that accompany this book.

All material copyright 1996-2023
J.F Kurose and K.W. Ross, All Rights Reserved

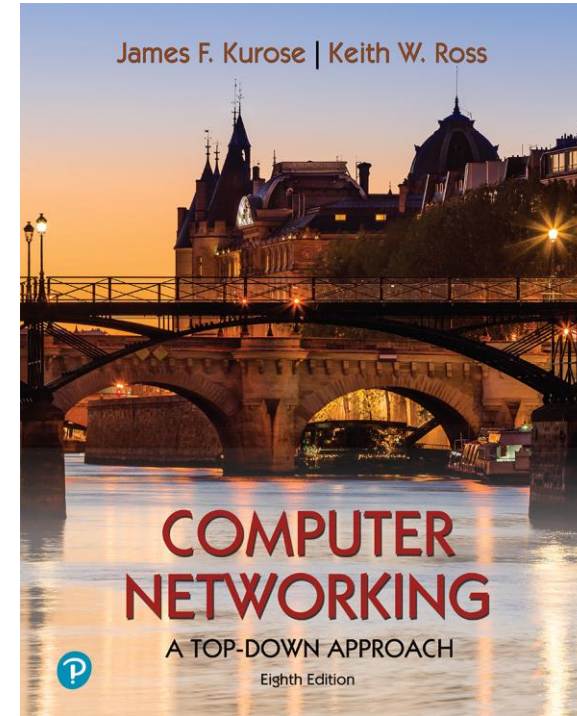

Computer Networking: A Top-Down Approach

8th edition

Jim Kurose, Keith Ross

Pearson, 2020

Network layer: roadmap

- Network layer overview
- Routing algorithms
- Network layer in the Internet

Network Layer in the Internet

- Suppose you want to connect billions of end points together!
- How does this affect addressing, routing, and forwarding in the network layer?

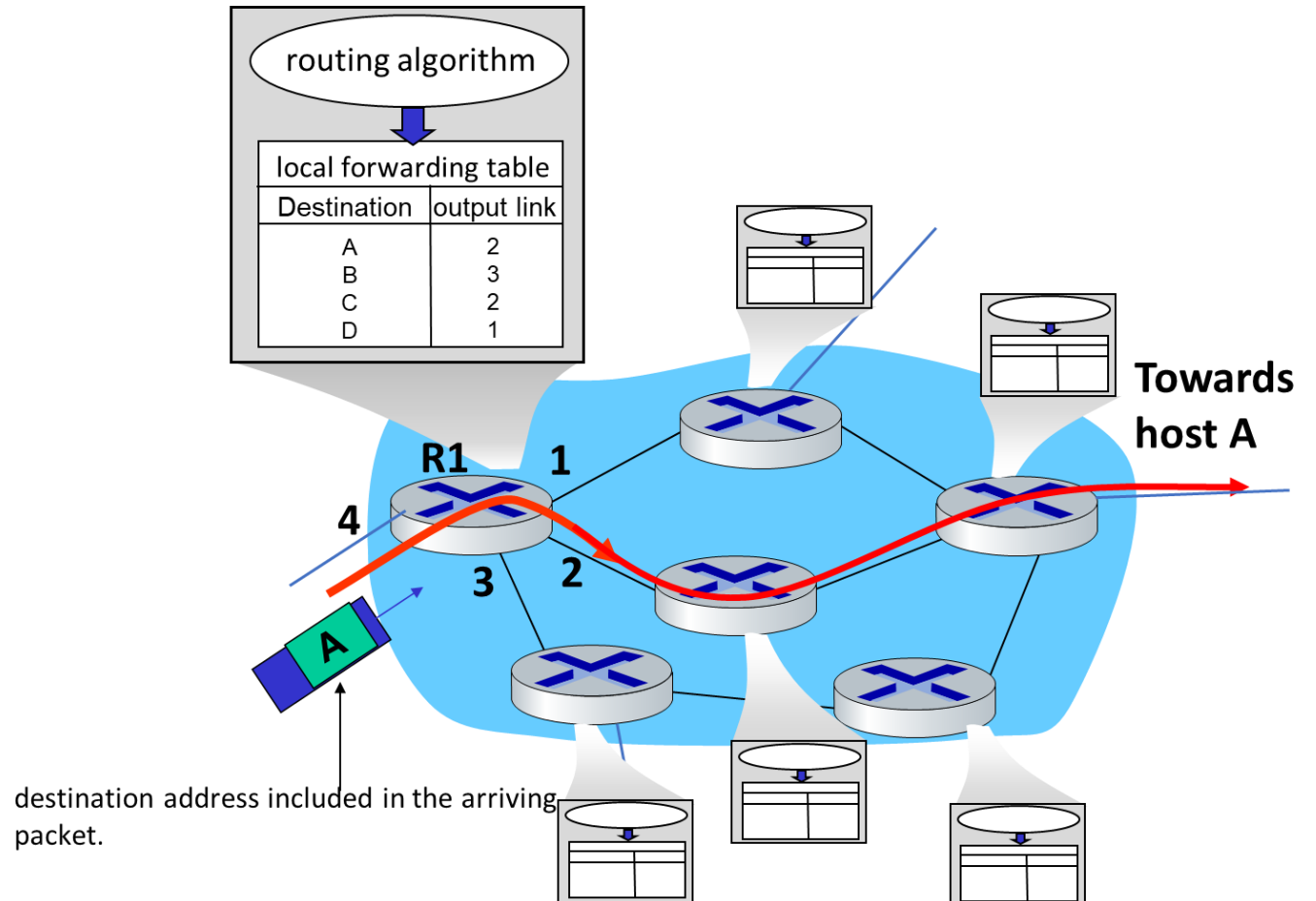

Network Layer in the Internet

- Suppose you want to connect billions of end points together!
- How does this affect addressing, routing, and forwarding in the network layer?
 - Forwarding tables would have to have billions of entries, one for each address
 - Routing algorithms would have to find a path for each individual address
 - Routing algorithms would have to run across millions of routers
 - ...

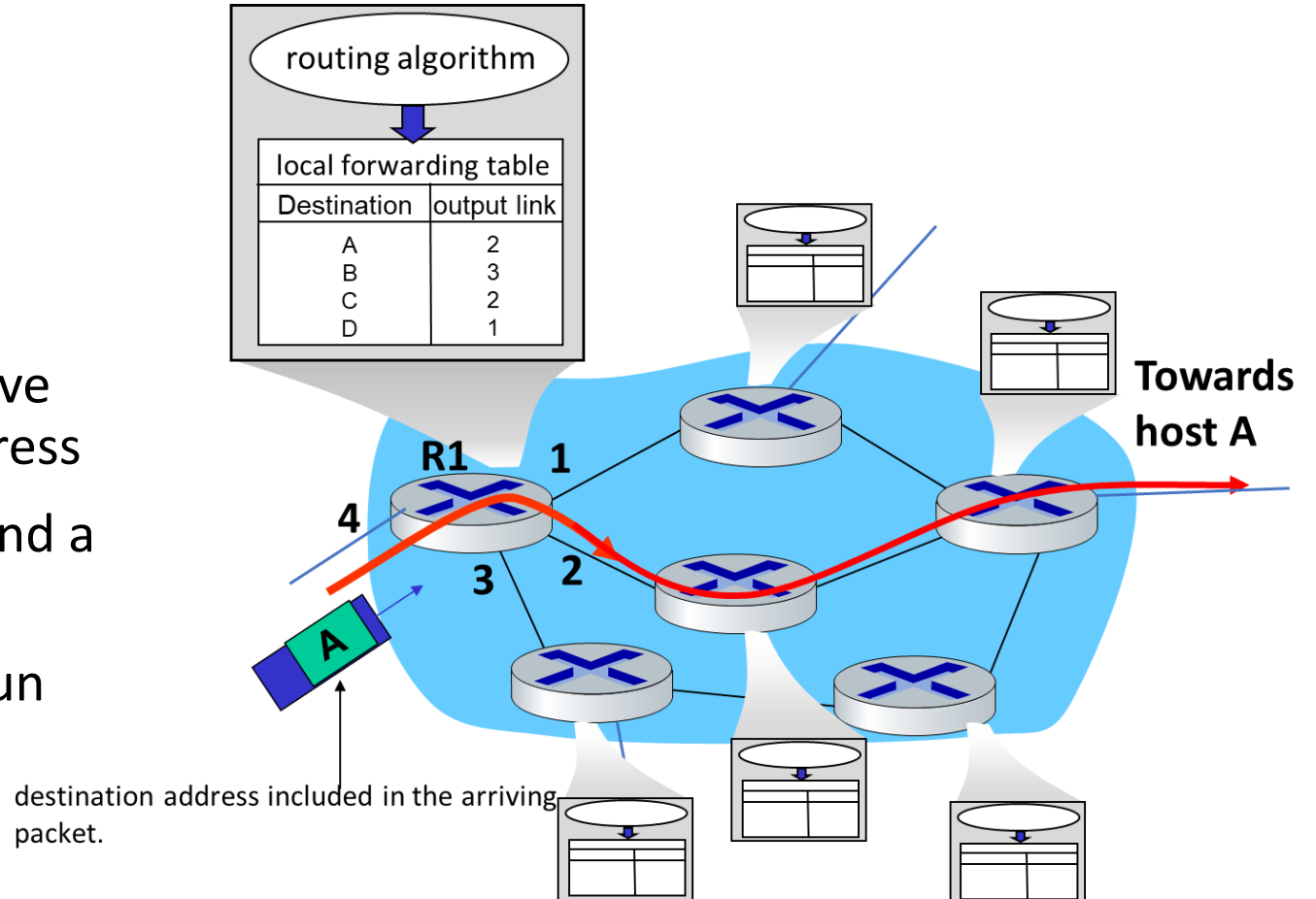

Network Layer in the Internet

- A “flat” network will not scale!
- Internet and its best-effort network layer are designed with hierarchy in mind
 - Addresses are hierarchical – hosts that are “close” together have addresses that can be combined into one “group identifier”
 - Routing is hierarchical – routers learn how to reach groups of addresses.
 - Forwarding is hierarchical – forwarding tables keep entries about paths to groups of addresses.

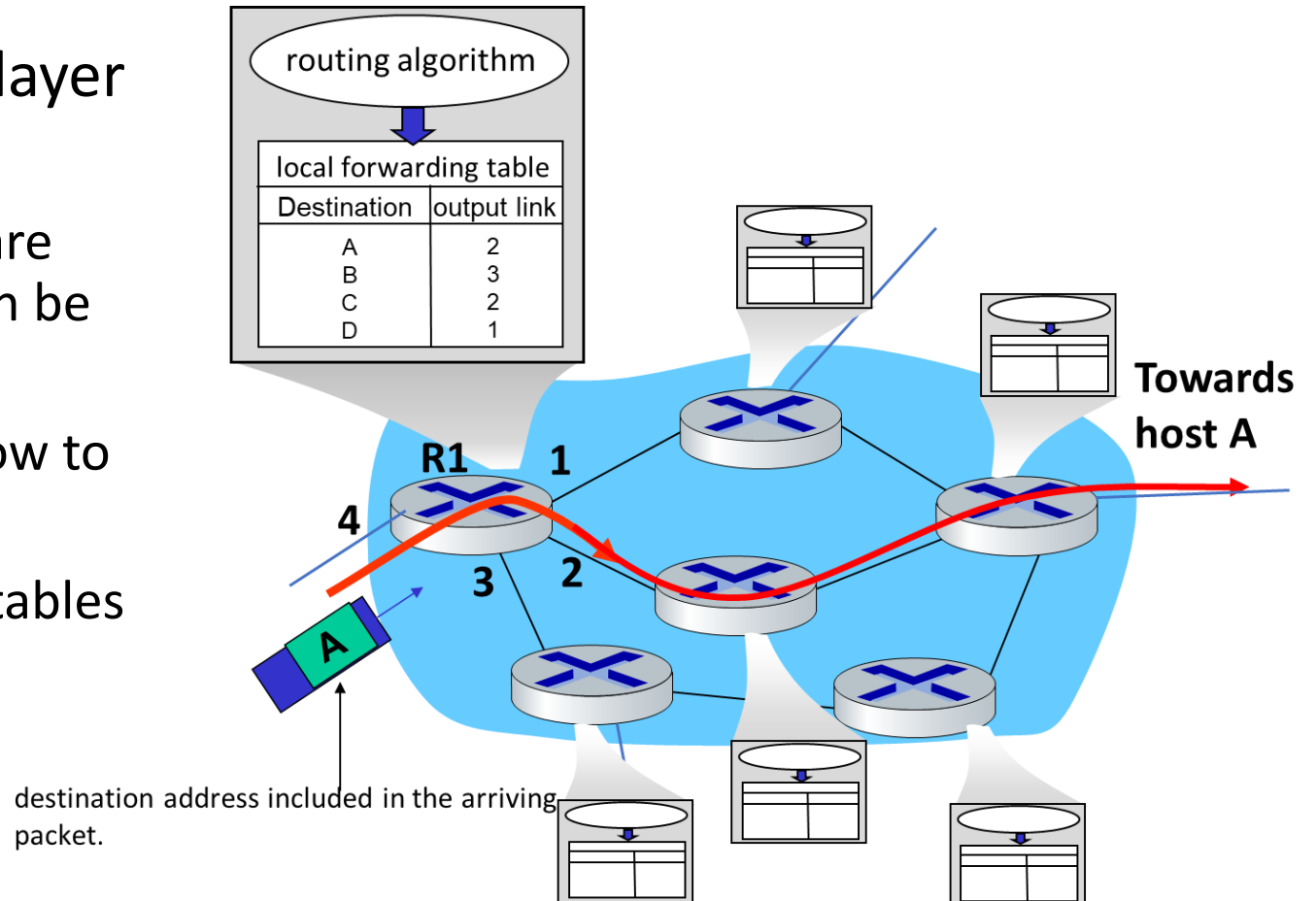

Network Layer in the Internet

- IP: Internet's best effort network-layer protocol.
- We'll discuss:
 - What IP datagrams look like
 - What IP **addresses** look like
 - How the network finds paths for datagrams going from one IP address to another (i.e., **routing** algorithms)
 - How routers **forward** packets
 - ...

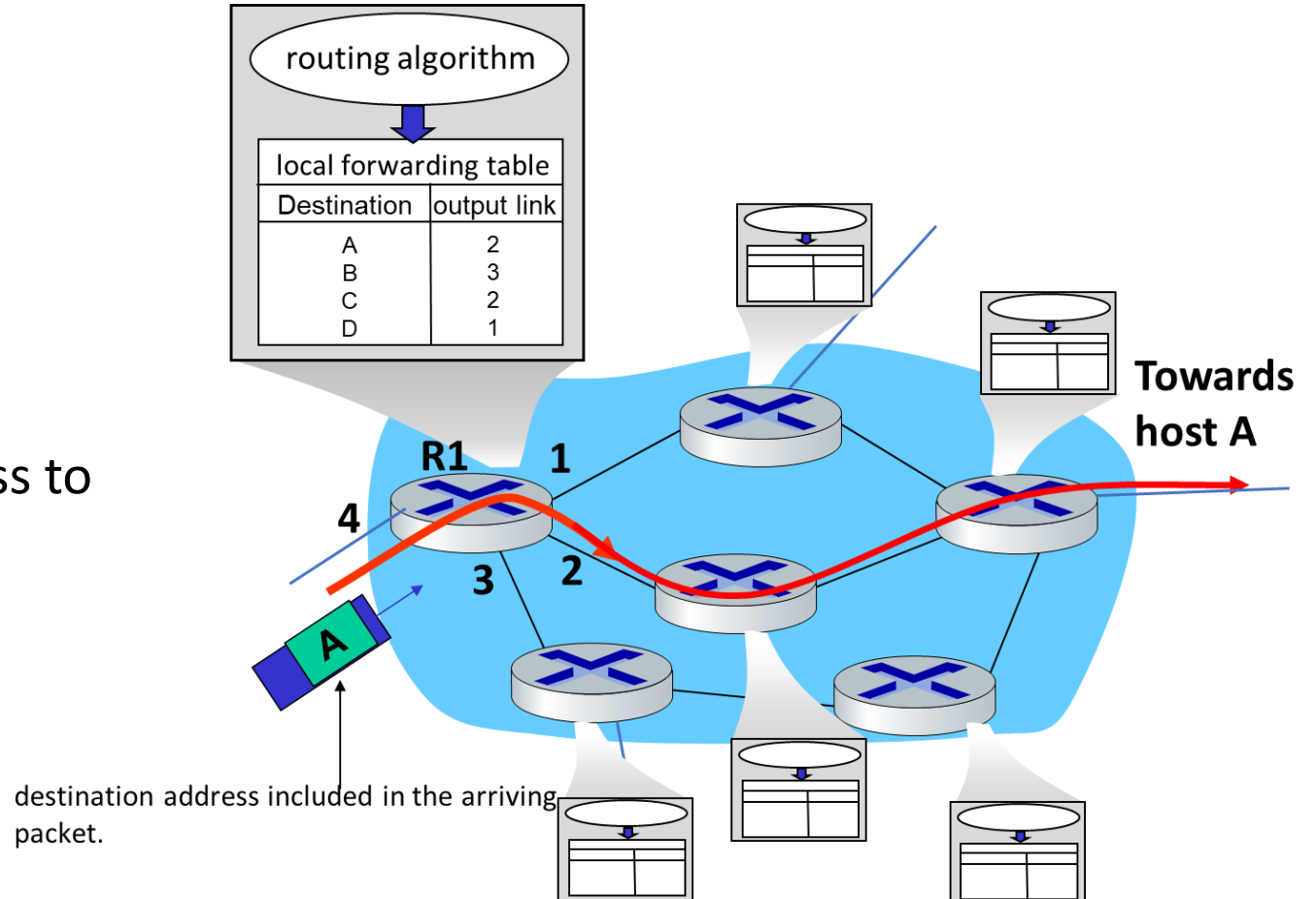

Network Layer in the Internet

- The Internet Protocol (IP)
 - Datagram format
 - Addressing
 - Network address translation
 - IPv6
- Internet Routing
- Internet Forwarding

Network Layer in the Internet

- The Internet Protocol (IP)
 - Datagram format
 - Addressing
 - Network address translation
 - IPv6
- Internet Routing
- Internet Forwarding

IP Standard

- IPv4 first and widely deployed Internet protocol
 - many problems in today's Internet
- IPv6 replacement
 - long (long!) time for deployment and use
 - 25 years and counting!
 - think of the much faster application-level changes in last 25 years: WWW, social media, streaming media, gaming, telepresence, ...
 - Why? We'll come back to this later in the lecture

IPv4 Datagram format

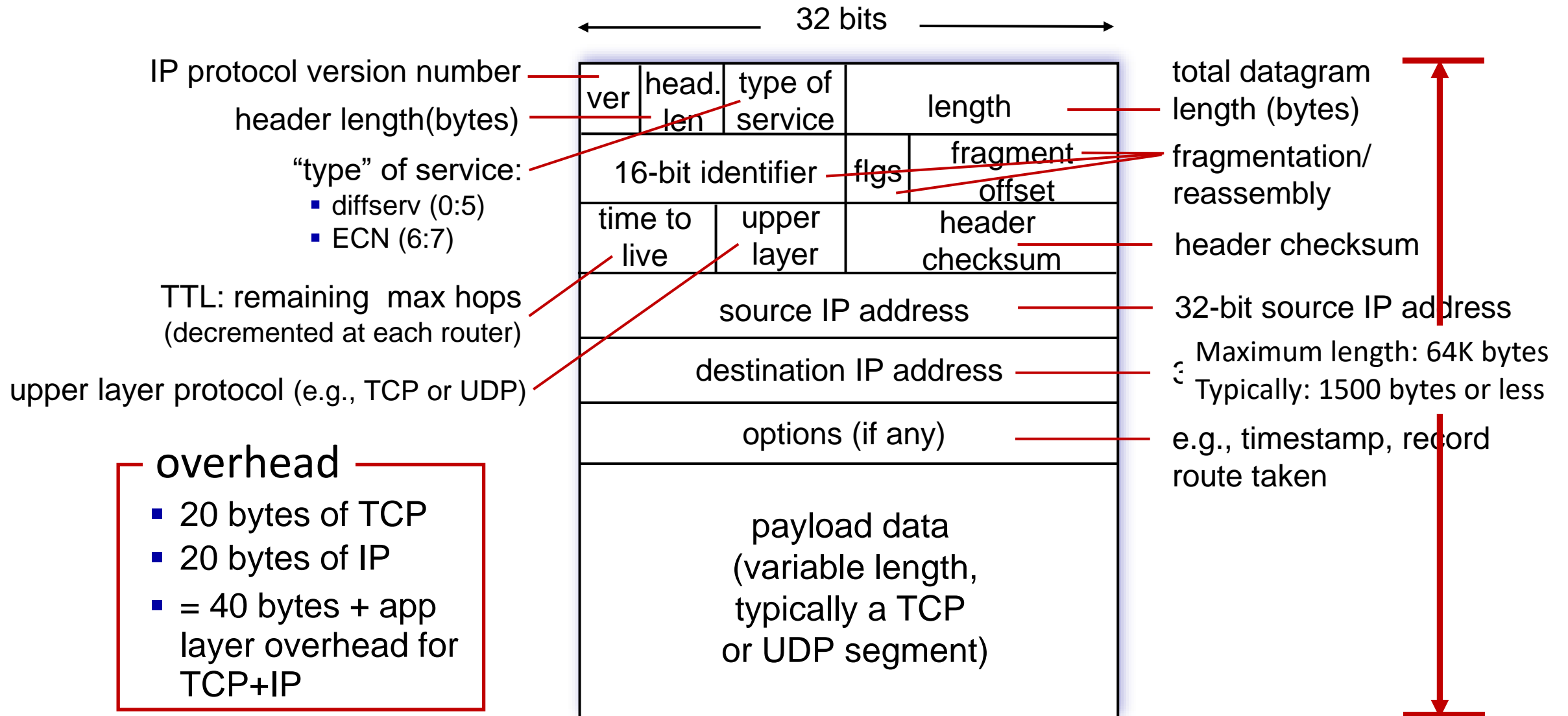

Network Layer in the Internet

- The Internet Protocol (IP)
 - Datagram format
 - Addressing
 - Network address translation
 - IPv6
- Internet Routing
- Internet Forwarding

IP addressing: introduction

- **IP address:** 32-bit identifier associated with each host or router *interface*
- **interface:** connection between host/router and physical link
 - router's typically have multiple interfaces
 - host typically has one or two interfaces (e.g., wired Ethernet, wireless 802.11)

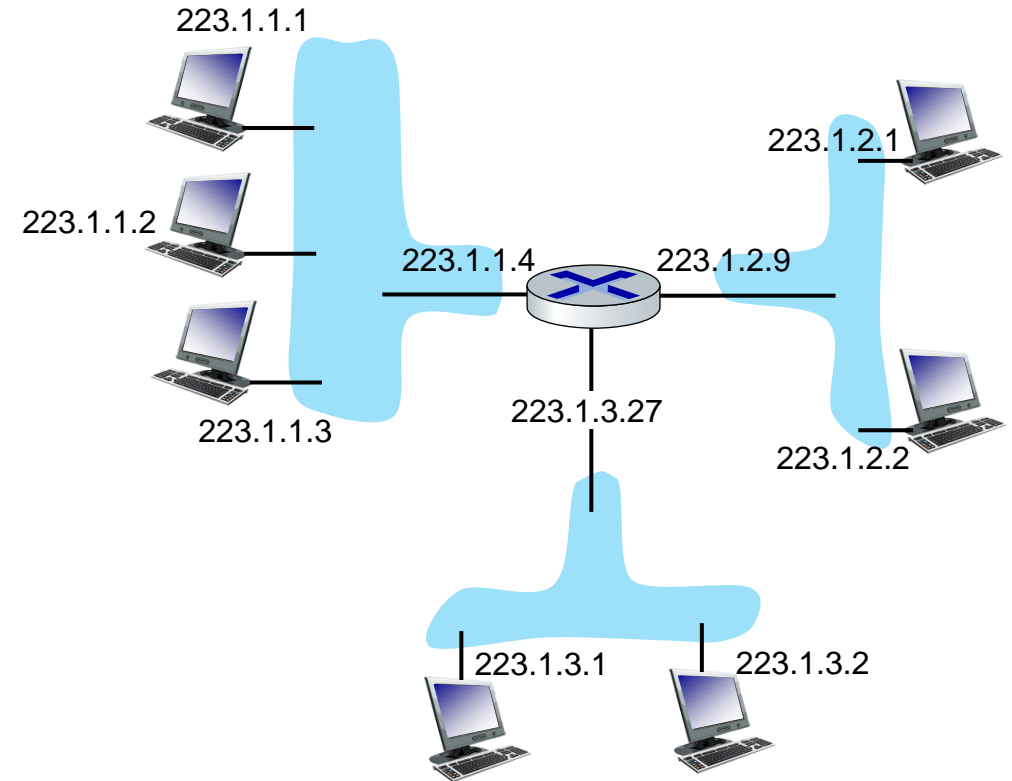

dotted-decimal IP address notation:

223.1.1.1 = $\underbrace{11011111}_{223} \underbrace{00000001}_{1} \underbrace{00000001}_{1} \underbrace{00000001}_{1}$

IP addressing: introduction

Q: how are interfaces (without an intervening router) actually connected?

A: we'll learn about that later

For now: don't need to worry about how two interfaces without an intervening router are connected

A: wired Ethernet interfaces connected by Ethernet switches

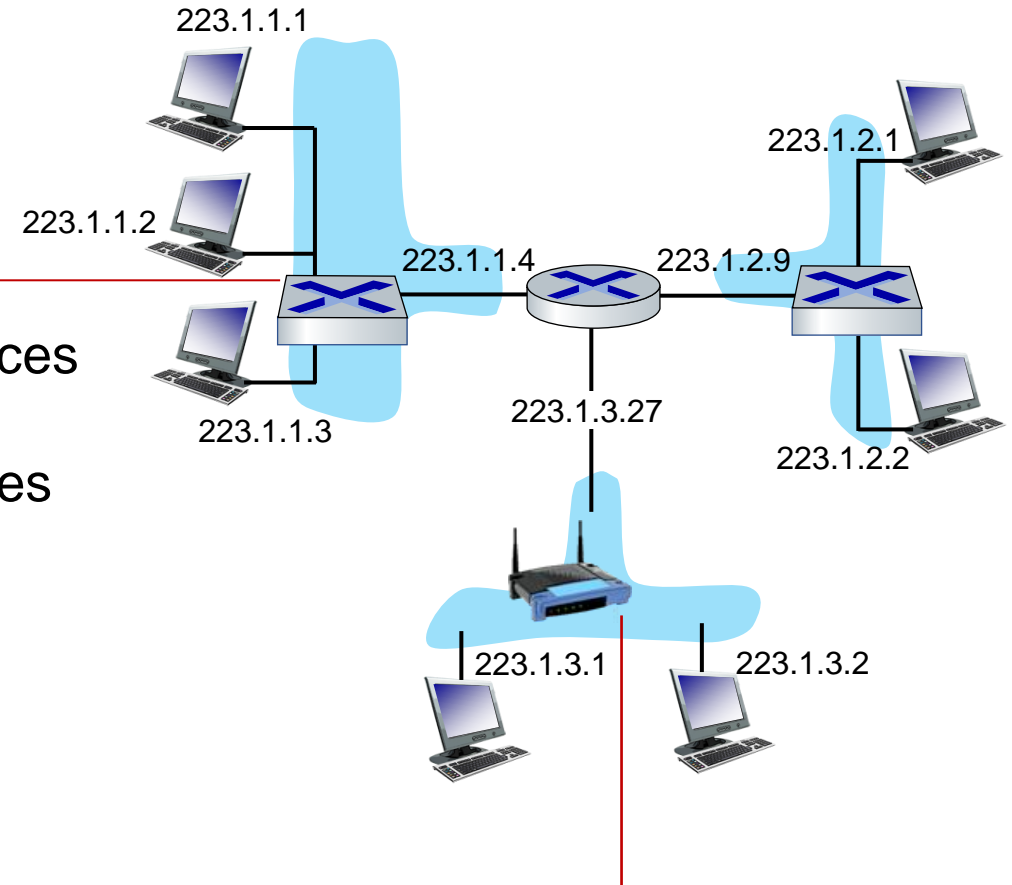

A: wireless WiFi interfaces connected by WiFi base station

IP addressing: properties

- **Global uniqueness:**
 - identifies hosts

- **Hierarchical structure:**
 - consists of Subnet part + Host part
 - is necessary for Internet to scale to large number of hosts
 - aids Internet routing

Subnets

- *What's a subnet ?*
 - device interfaces that can physically reach each other **without passing through an intervening router**
- IP addresses have structure:
 - **subnet part (or prefix)**: devices in same subnet have common high order bits
 - **host part: remaining** low order bits

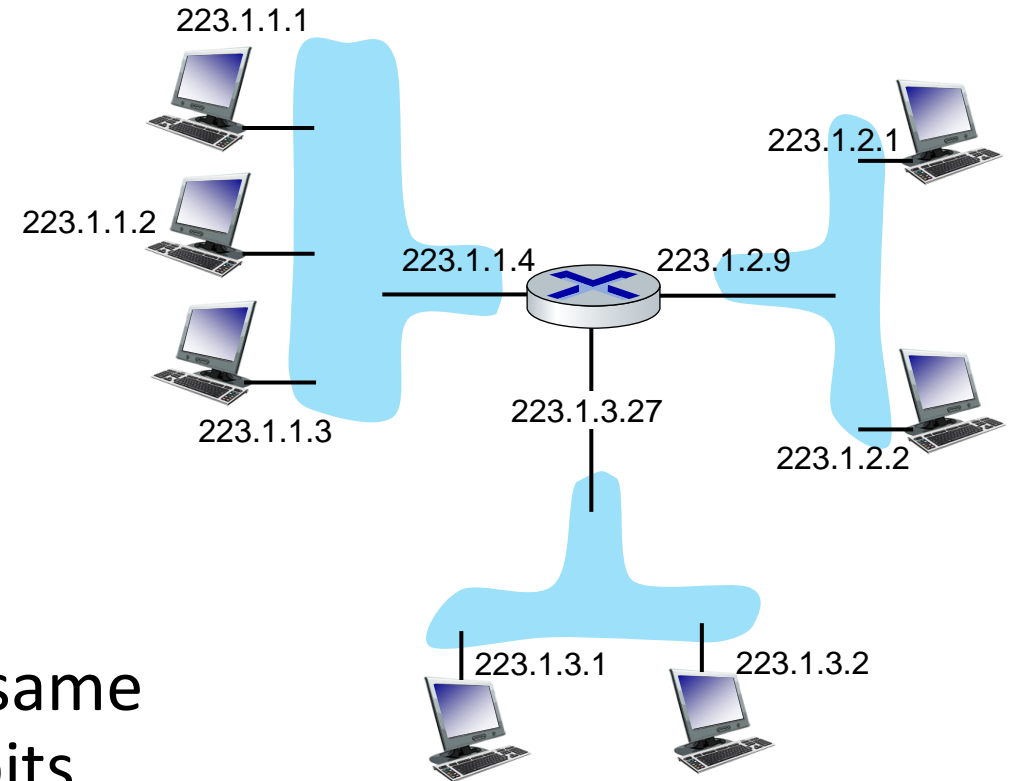

network consisting of 3 subnets

Subnets

Recipe for defining subnets:

- detach each interface from its host or router, creating “islands” of isolated networks
- each isolated network is called a *subnet*

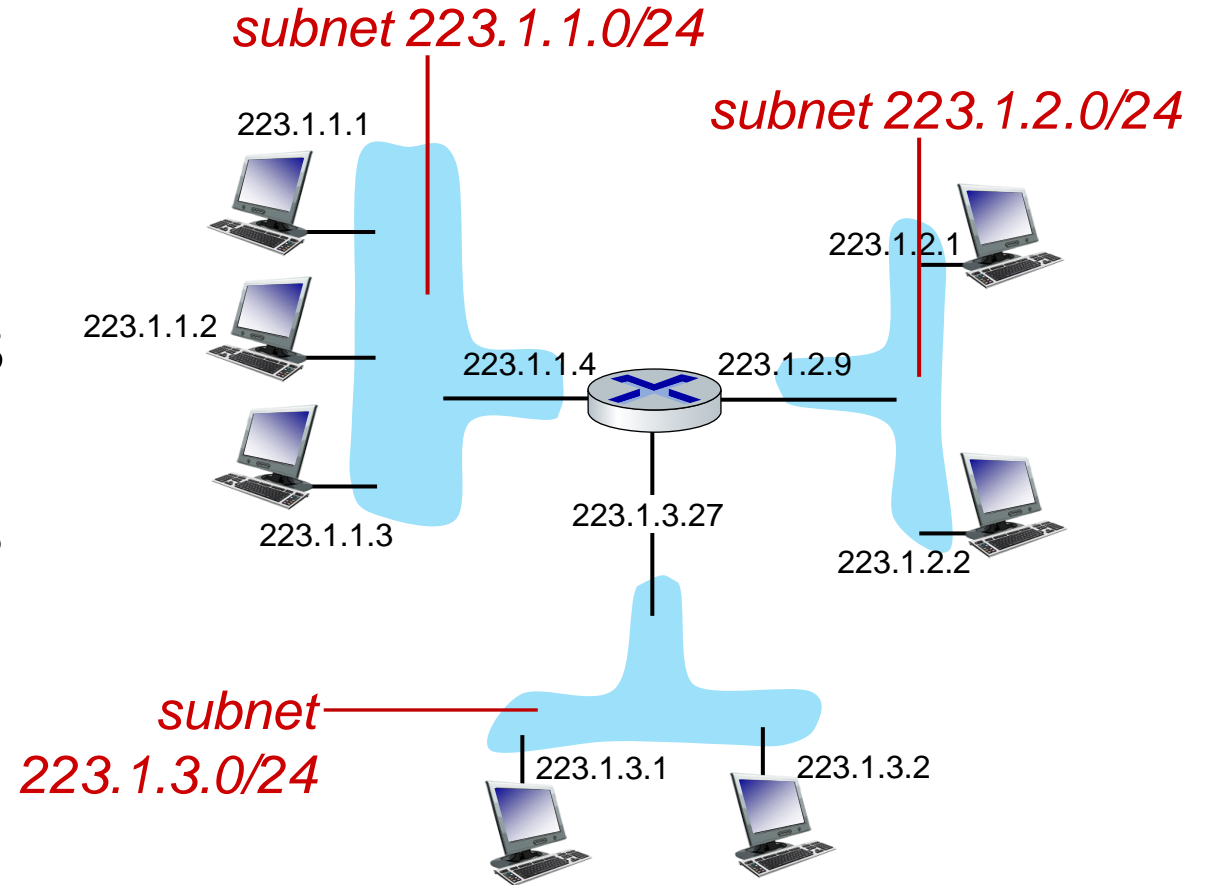

subnet mask: /24

(high-order 24 bits: subnet part of IP address)

Subnets

- where are the subnets?
- what are the /24 subnet addresses?

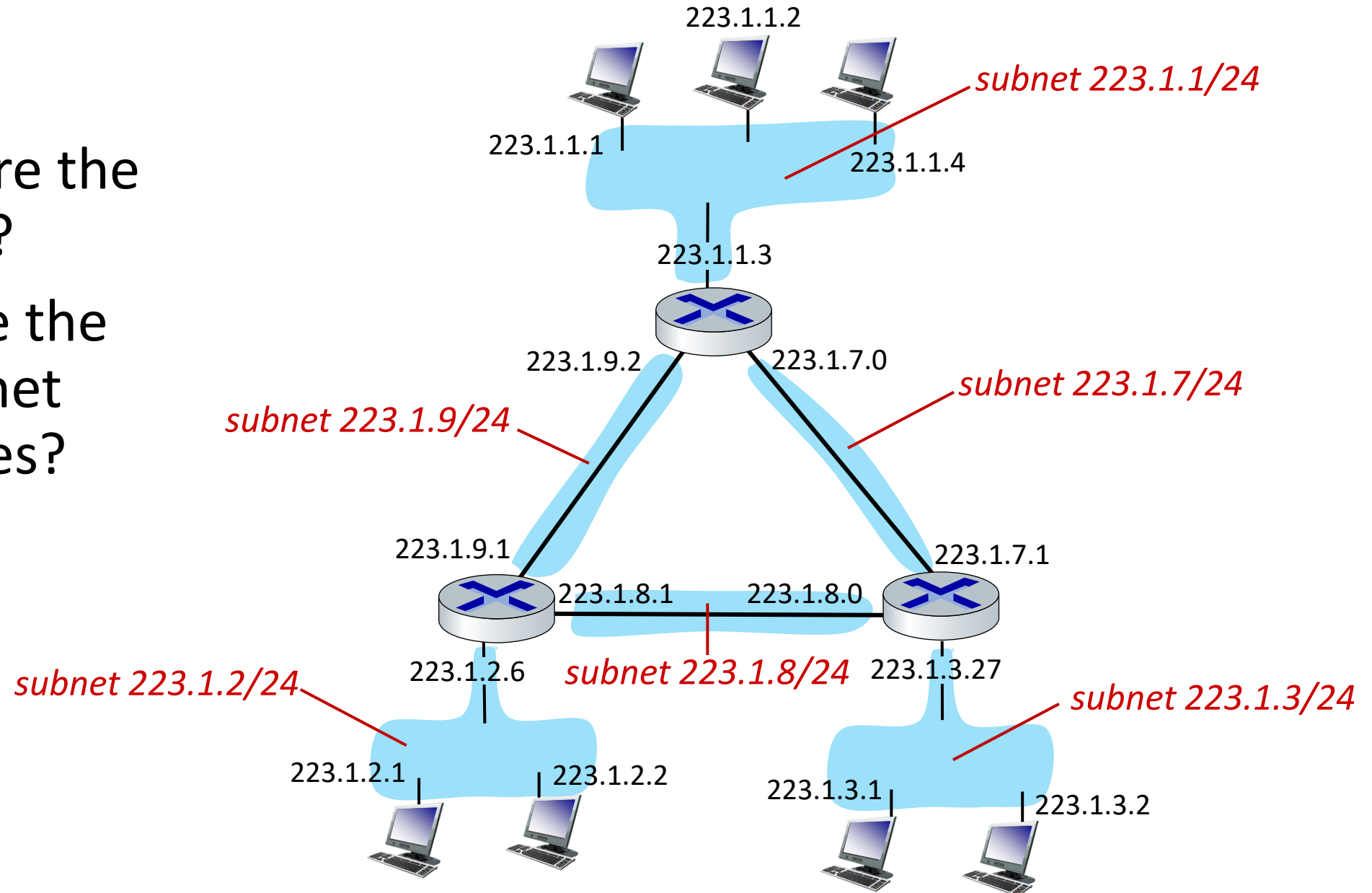

IP addressing: CIDR

CIDR: Classless InterDomain Routing (pronounced “cider”)

- subnet portion of address of arbitrary length
- address format: **a.b.c.d/x**, where x is # bits in subnet portion of address

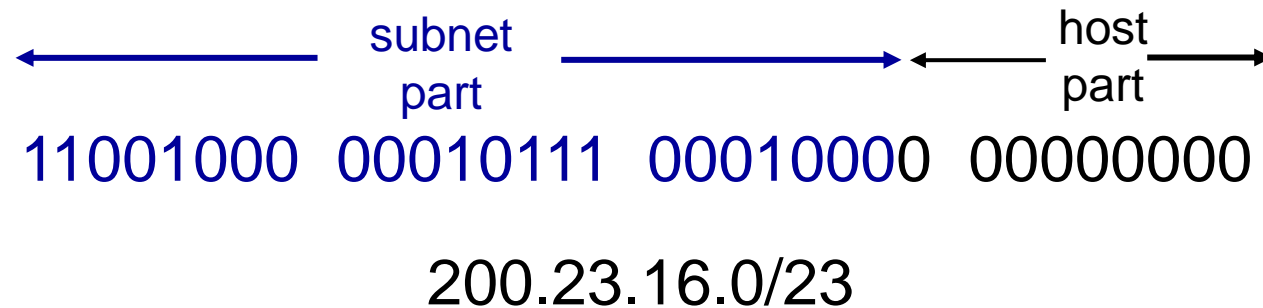

IP addressing: CIDR

Q: What is the range of subnet 200.23.16.64/26?

- 6 free bits or 64 addresses
- Last 8 bits are of the format 01XXX XXXX
- The range is **200.23.16.64 - 200.23.16.127**

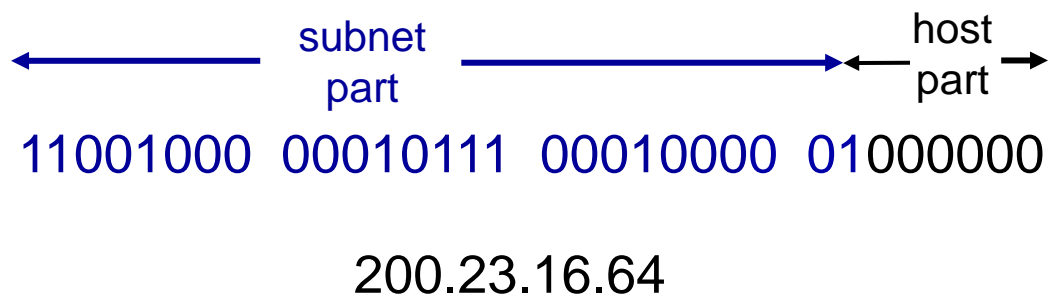

to

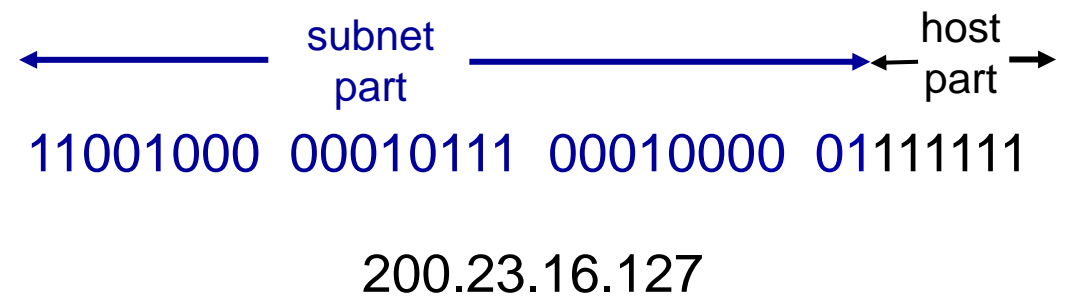

Route Aggregation

Recall:

- Forwarding table maps destination addresses to outgoing link
- As the number of possible IP (4 billion!) is huge, rows of forwarding table lists **ranges of address**, rather than individual hosts

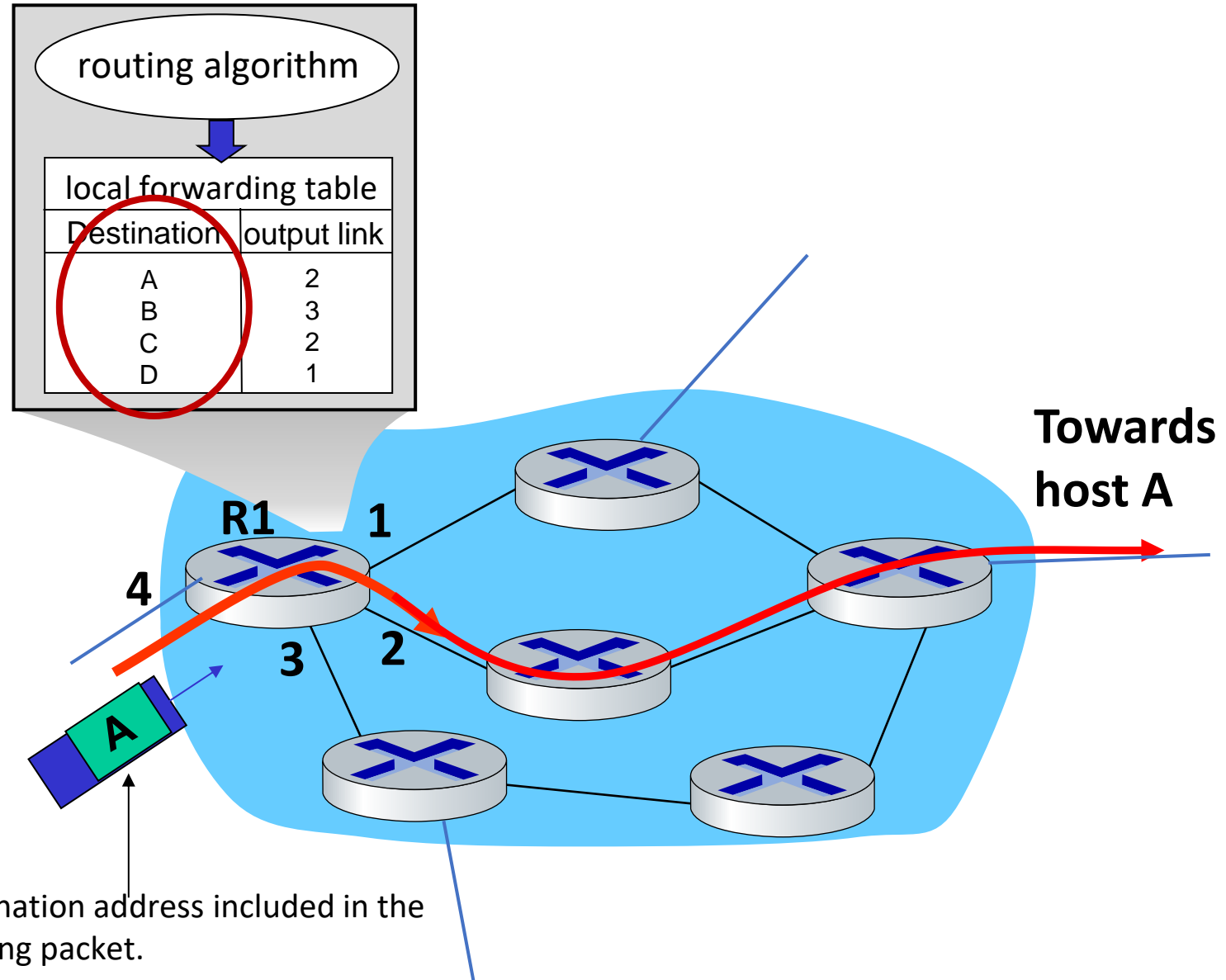

Route Aggregation

Recall:

- Forwarding table maps destination addresses to outgoing link
- As the number of possible IP (4 billion!) is huge, rows of forwarding table lists **ranges of address**, rather than individual hosts

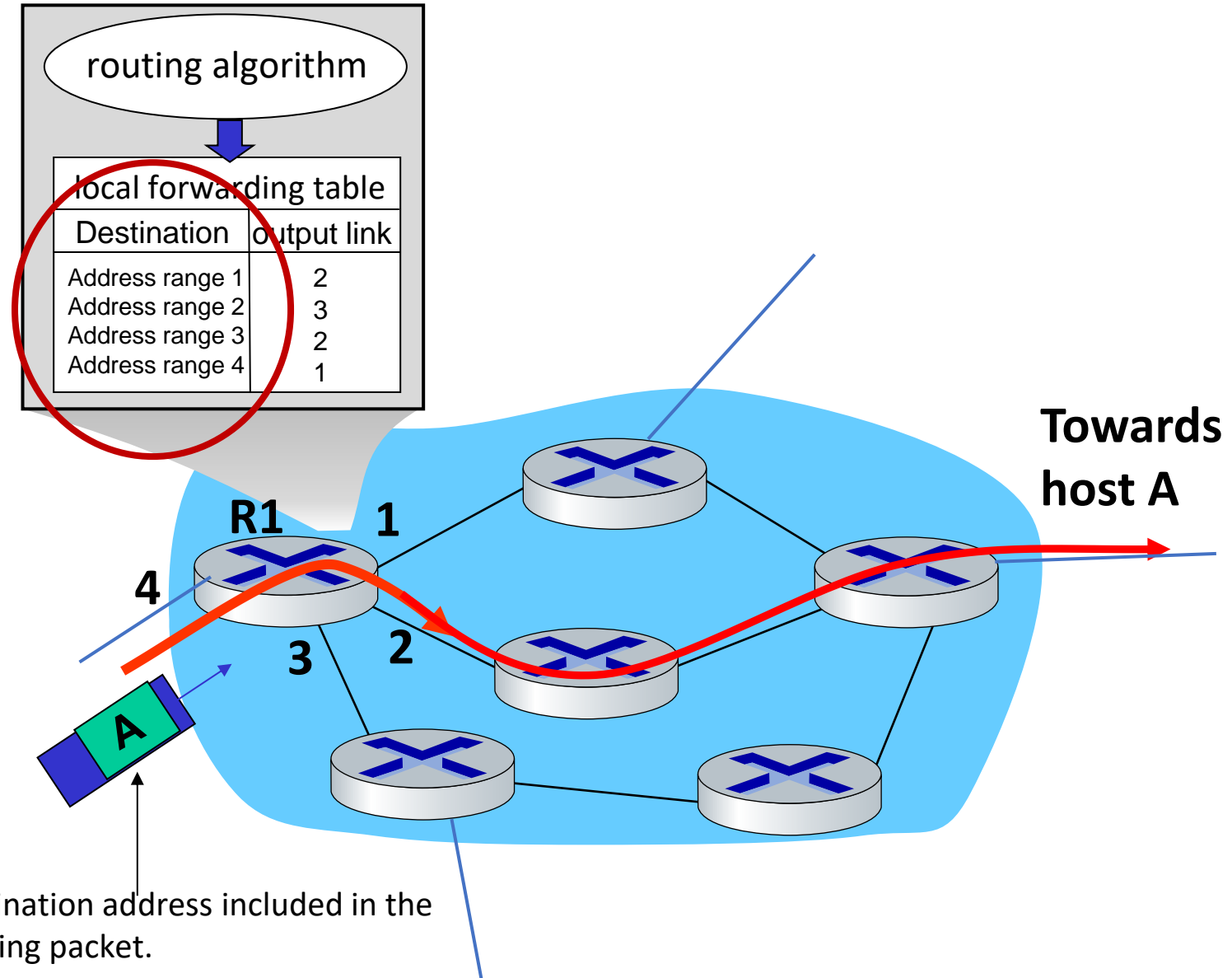

Route Aggregation

Longest prefix matching

- For a given destination address, determine the output link based on the entry with *longest address prefix* that matches the address
- E.g., the destination address 200.23.16.1 falls into ranges of both the first and second rows in the forwarding table; it is forwarded to output link 2 based on longest prefix matching

local forwarding table	
Destination	output link
11001000 00010111 00010000 00000000 / 23 200.23.16.0 / 23	2
11001000 00010111 00010000 00000000 / 20 200.23.16.0 / 20	3
11001000 00010111 00011000 00000000 / 23 200.23.24.0 / 23	2
Otherwise	1

Hierarchical addressing

Q: how does *network* get subnet part of IP address?

A: gets allocated portion of its provider ISP's address space

ISP's block 11001000 00010111 00010000 00000000 200.23.16.0/20

ISP can then allocate out its address space in 8 blocks:

Organization 0	<u>11001000 00010111 00010000</u>	00000000	200.23.16.0/23
Organization 1	<u>11001000 00010111 00010010</u>	00000000	200.23.18.0/23
Organization 2	<u>11001000 00010111 00010100</u>	00000000	200.23.20.0/23
...
Organization 7	<u>11001000 00010111 00011110</u>	00000000	200.23.30.0/23

Route aggregation example

hierarchical addressing allows efficient advertisement of routing information:

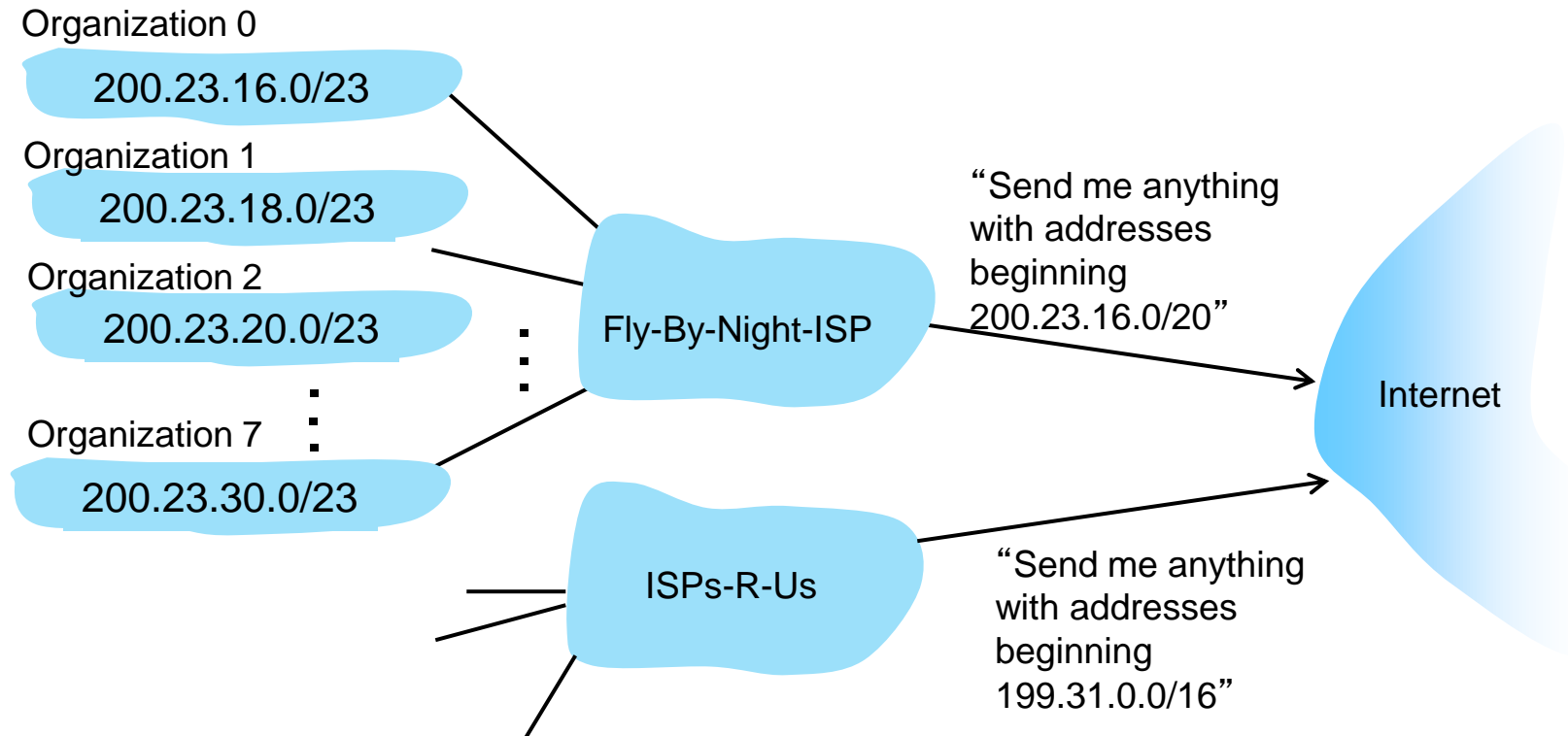

Route aggregation example

- Organization 1 moves from Fly-By-Night-ISP to ISPs-R-Us
- ISPs-R-Us now advertises a more specific route to Organization 1

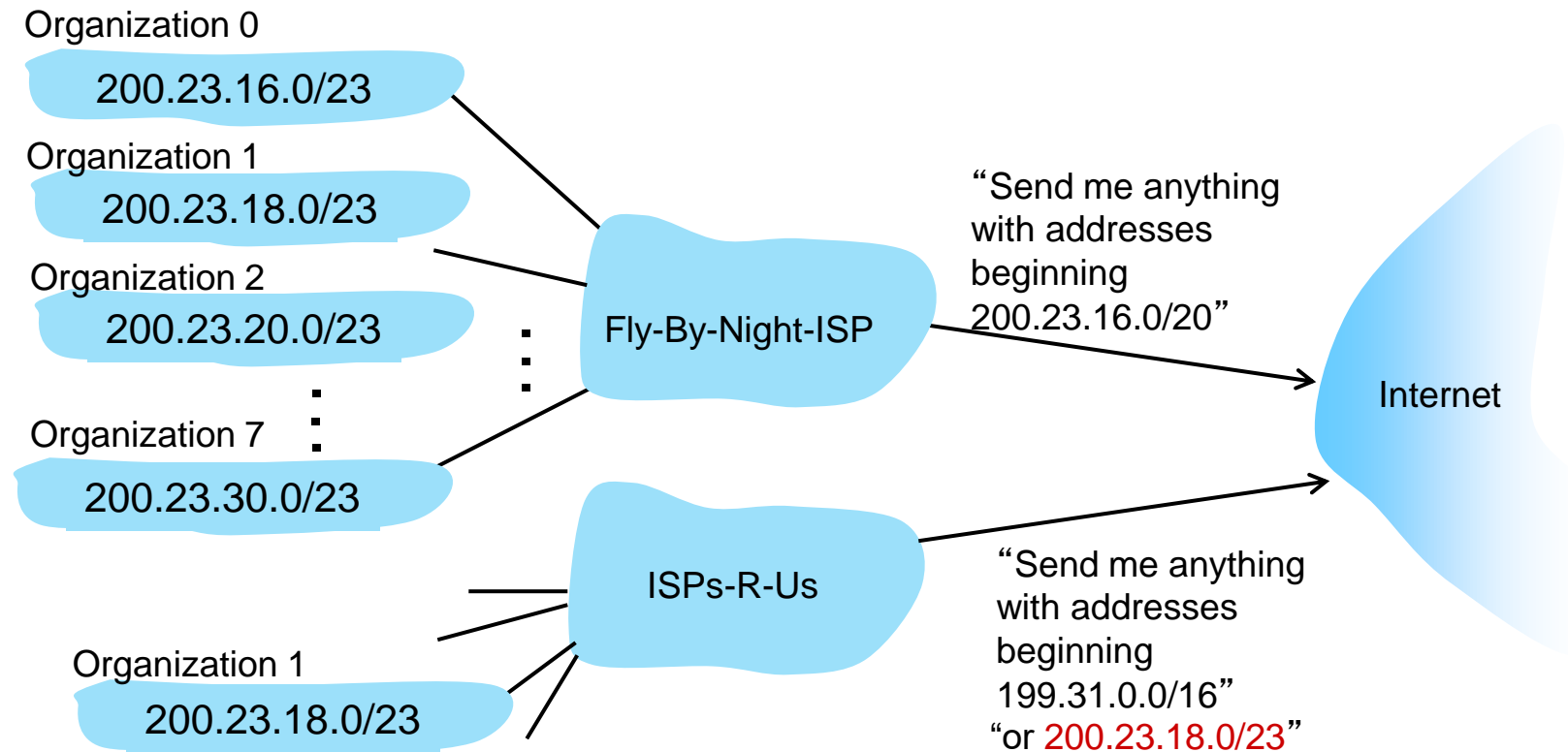

Route aggregation example

- Organization 1 moves from Fly-By-Night-ISP to ISPs-R-Us
- ISPs-R-Us now advertises a more specific route to Organization 1

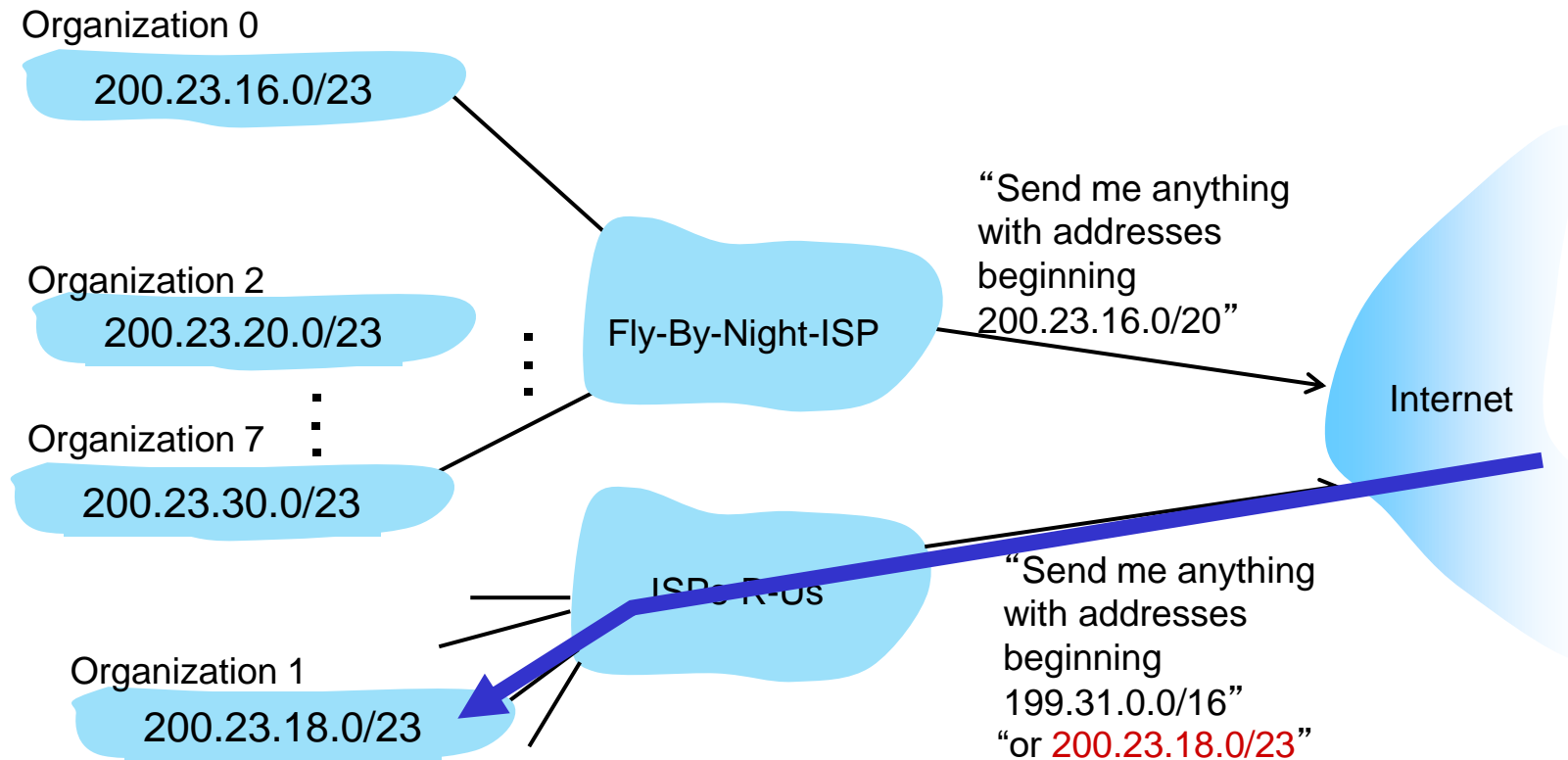

In-Class Exercise

Q: A router connects 3 subnets. Each subnet must have prefix 200.23.16.0/24

- Subnet 1 supports up to 123 interfaces
- Subnet 2 and subnet 3 up to 60 interfaces
- What should the 3 subnet addresses be?

Network Layer in the Internet

- The Internet Protocol (IP)
 - Datagram format
 - Addressing
 - Network address translation
 - IPv6
- Internet Routing
- Internet Forwarding

NAT: network address translation

NAT: all devices in local network share just **one** IPv4 address as far as outside world is concerned

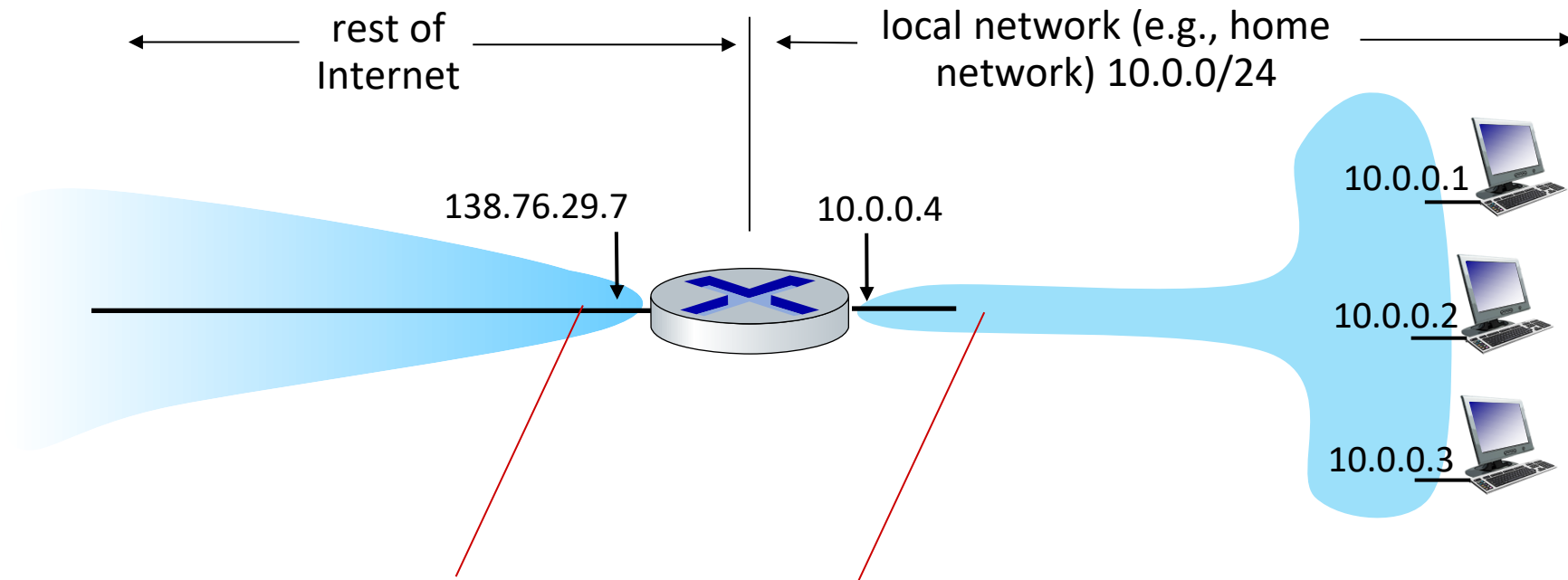

all datagrams *leaving* local network have *same* source NAT IP address: 138.76.29.7, but *different* source port numbers

datagrams with source or destination in this network have 10.0.0/24 address for source, destination (as usual)

NAT: network address translation

NAT “box” must (transparently):

- **outgoing datagrams: replace** (source IP address, port #) of every outgoing datagram to (NAT IP address, new port #)
 - remote clients/servers will respond using (NAT IP address, new port #) as destination address
- **remember (in NAT translation table)** every (source IP address, port #) to (NAT IP address, new port #) translation pair
- **incoming datagrams: replace** (NAT IP address, new port #) in destination fields of every incoming datagram with corresponding (source IP address, port #) stored in NAT table

NAT: network address translation

2: NAT router changes datagram source address from 10.0.0.1, 3345 to 138.76.29.7, 5001, updates table

1: host 10.0.0.1 sends datagram to 128.119.40.186, 80

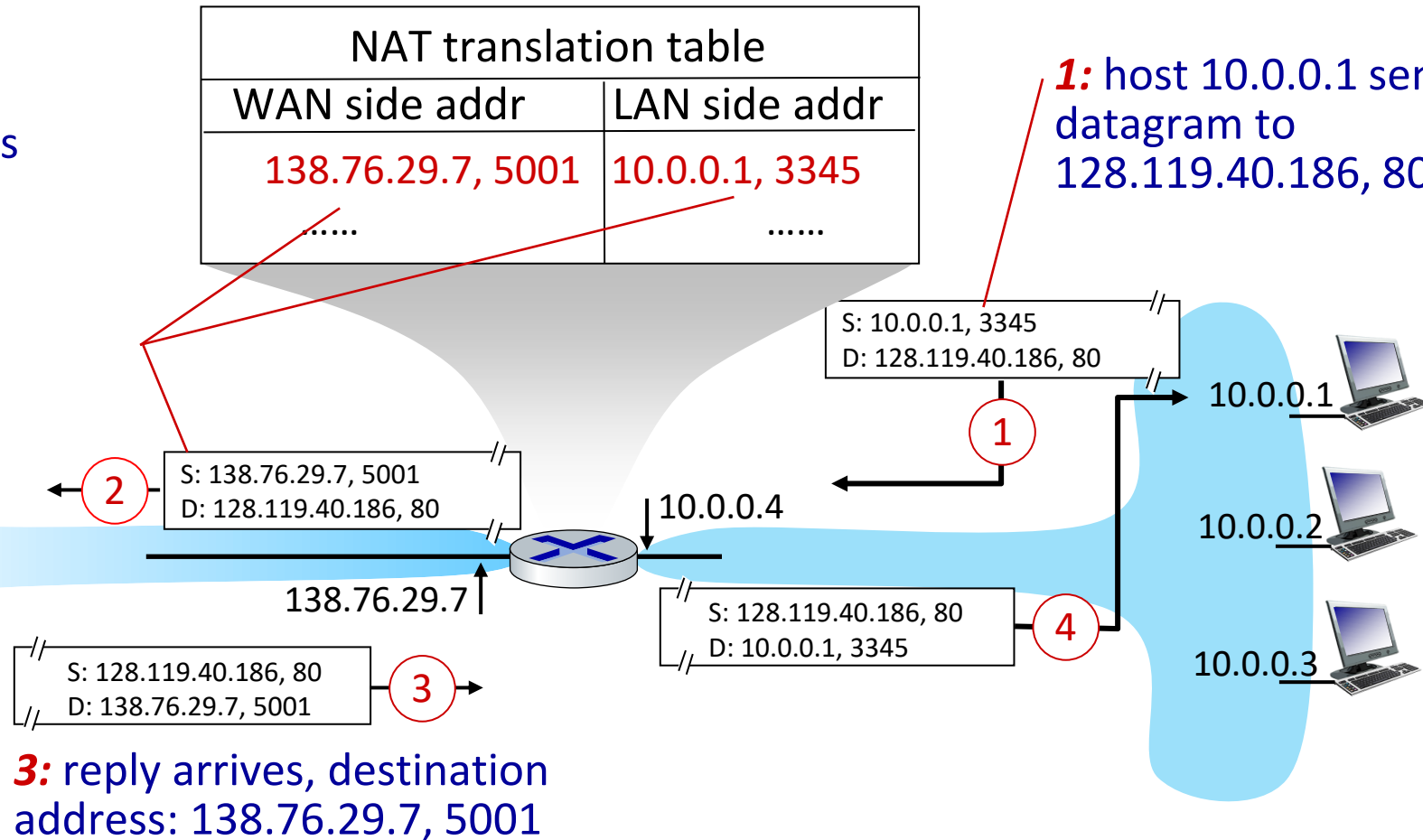

NAT: network address translation

- all devices in local network have 32-bit addresses in a “private” IP address space (10/8, 172.16/12, 192.168/16 prefixes) that can only be used in local network
- advantages:
 - just **one** IP address needed from provider ISP for *all* devices
 - can change addresses of host in local network without notifying outside world
 - can change ISP without changing addresses of devices in local network
 - security: devices inside local net not directly addressable, visible by outside world

NAT: network address translation

- NAT has been controversial:
 - Network devices “should” only process up to layer 3
 - address “shortage” should be solved by IPv6
 - violates end-to-end argument (port # manipulation by network-layer device)
- NAT traversal: what if client wants to connect to server behind NAT?
- but NAT is here to stay:
 - extensively used in home and institutional nets, 4G/5G cellular nets

What you need to know about NATs

- How NATs work
 - E.g., given an example scenario like the ones in the slides, and the port NAT chooses for an incoming connection, you should be able to complete the IP addresses and ports in packets going into and out of the NAT.
- Understand the reasons a NAT can be beneficial
- Understand the problems a NAT can cause.

Network Layer in the Internet

- The Internet Protocol (IP)
 - Datagram format
 - Addressing
 - Network address translation
 - IPv6
- Internet Routing
- Internet Forwarding

IPv6: motivation

- **initial motivation:** 32-bit IPv4 address space would be completely allocated
- additional motivation:
 - speed processing/forwarding
 - E.g., IPv4 has a (long) 40-byte fixed length header
 - enable different network-layer treatment of “flows”
 - E.g., different network-layer service for latency-sensitive traffic such as video conferencing compared to not-so-sensitive traffic such as a file download.

IPv6 datagram format

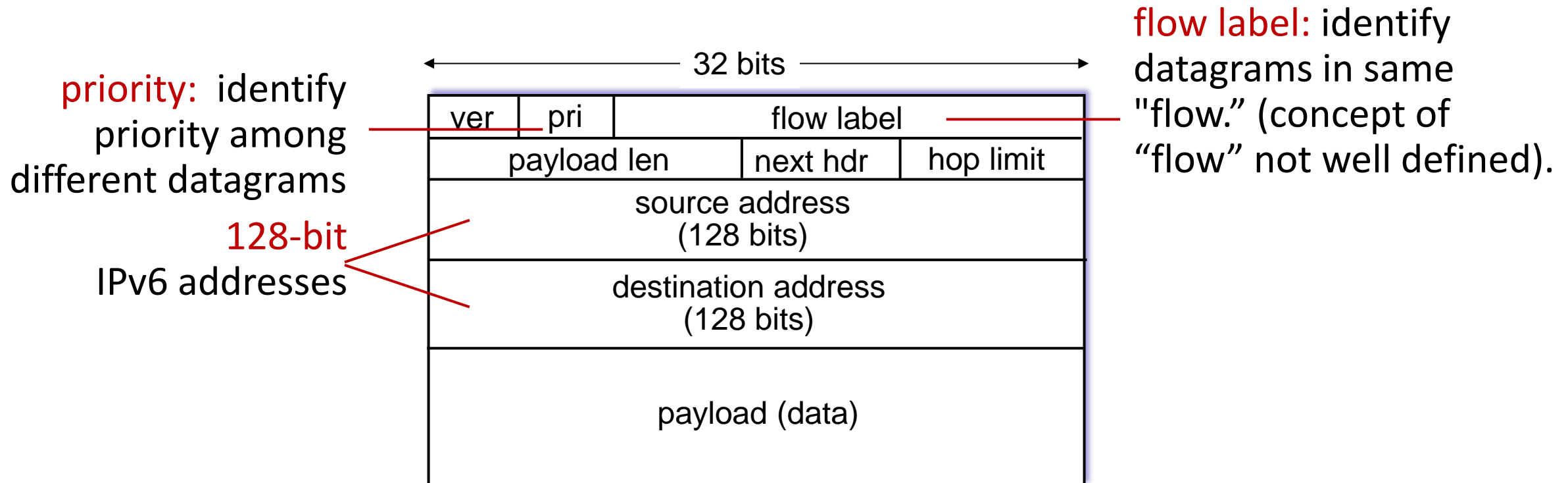

What's missing (compared with IPv4):

- no checksum (to speed processing at routers)
- no fragmentation/reassembly
- no options (available as upper-layer, next-header protocol at router)

Transition from IPv4 to IPv6

- not all routers can be upgraded simultaneously
 - no “flag days”
 - how will network operate with mixed IPv4 and IPv6 routers?
- **tunneling**: IPv6 datagram carried as *payload* in IPv4 datagram among IPv4 routers (“packet within a packet”)
 - tunneling used extensively in other contexts (4G/5G)

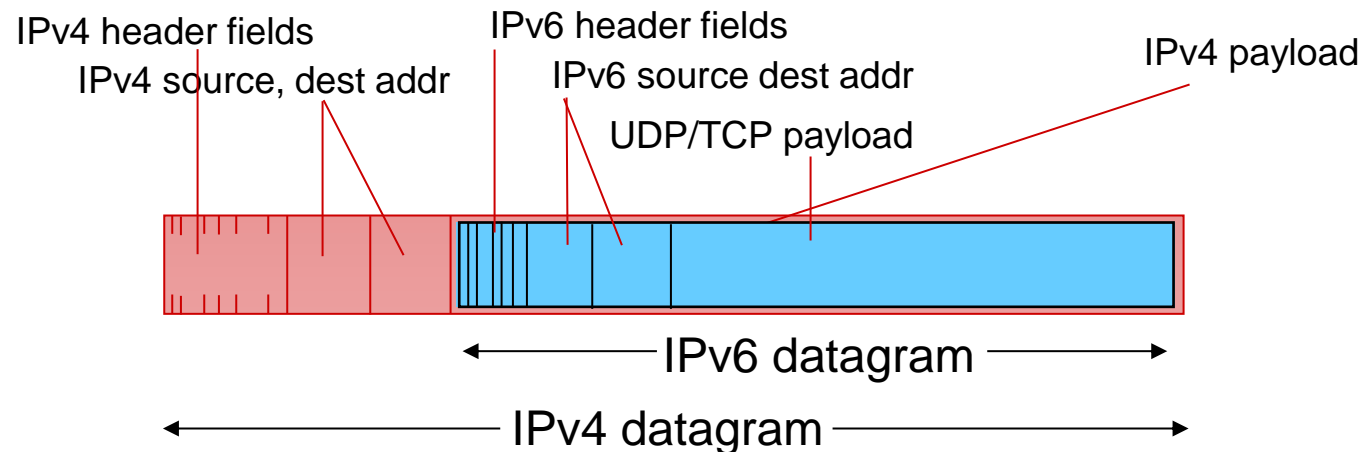

Tunneling and encapsulation

Ethernet connecting two IPv6 routers:

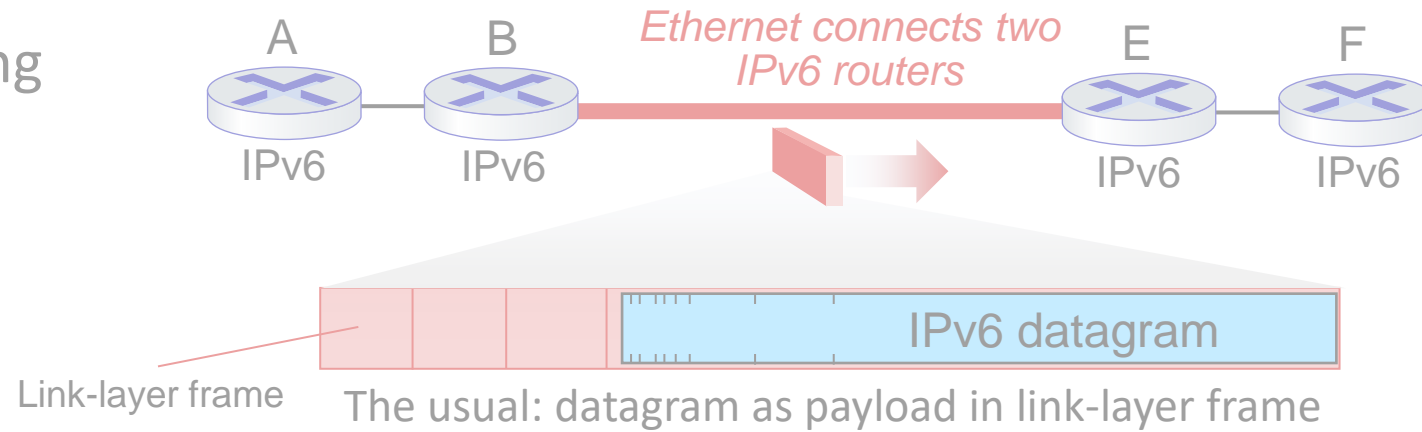

IPv4 network connecting two IPv6 routers

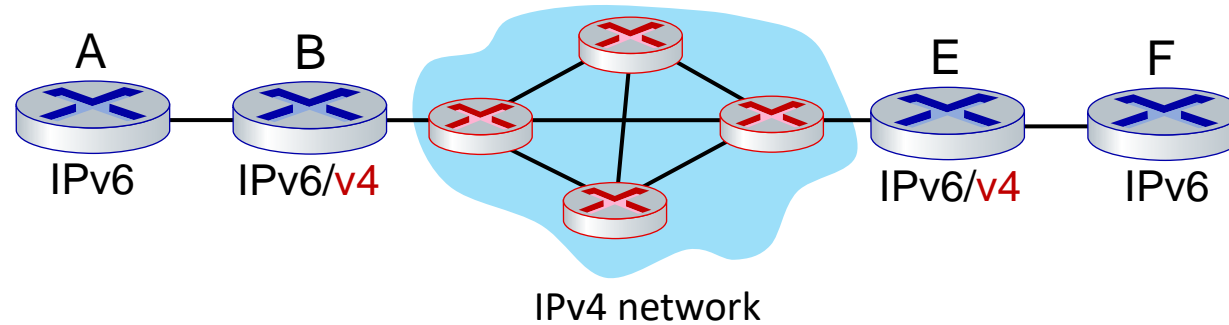

Tunneling and encapsulation

Ethernet connecting two IPv6 routers:

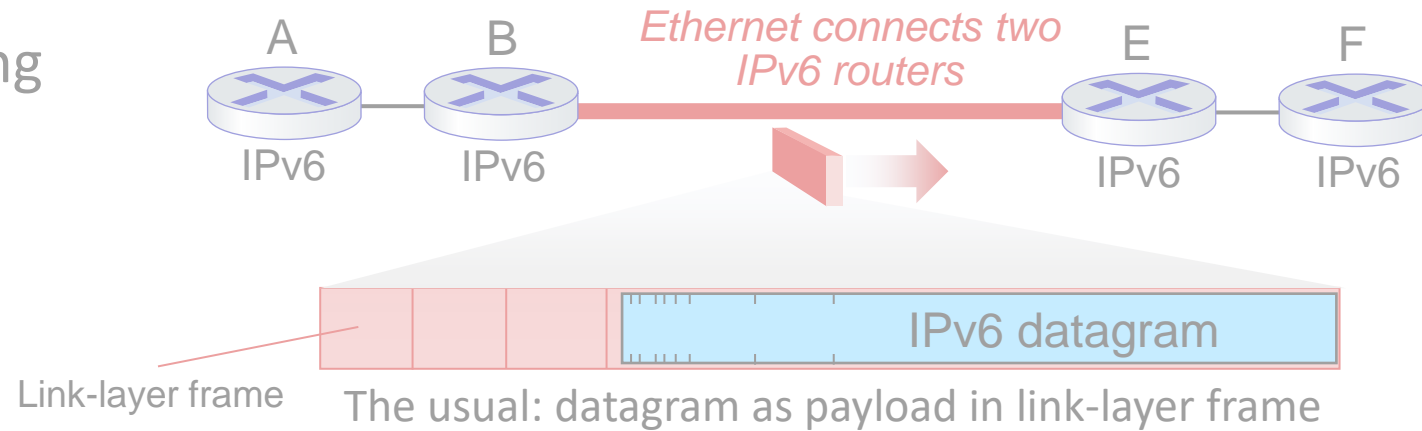

IPv4 tunnel connecting two IPv6 routers

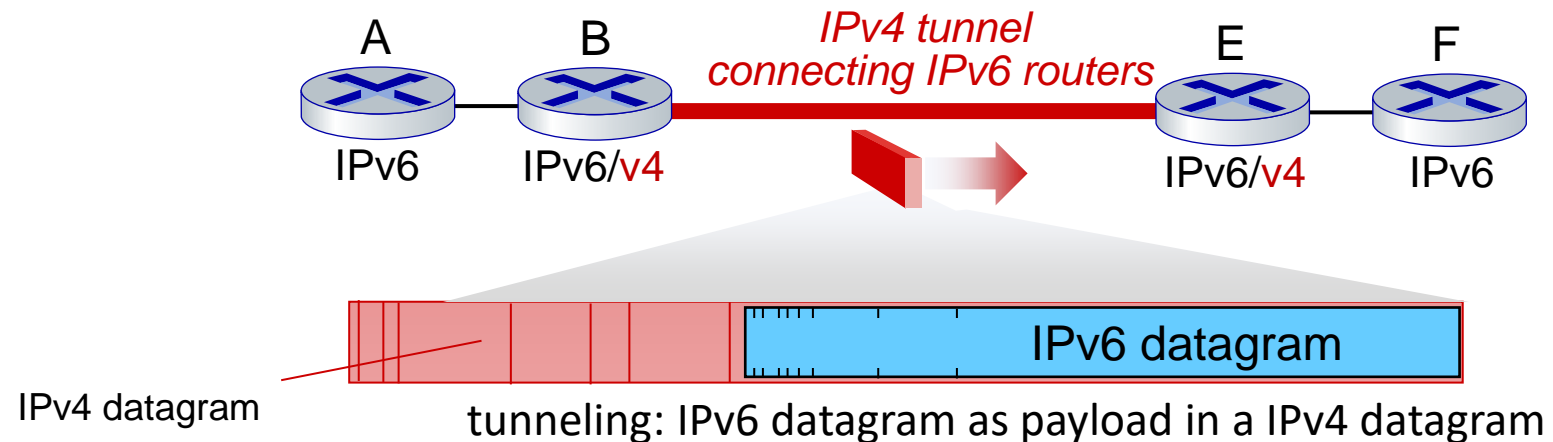

Tunneling

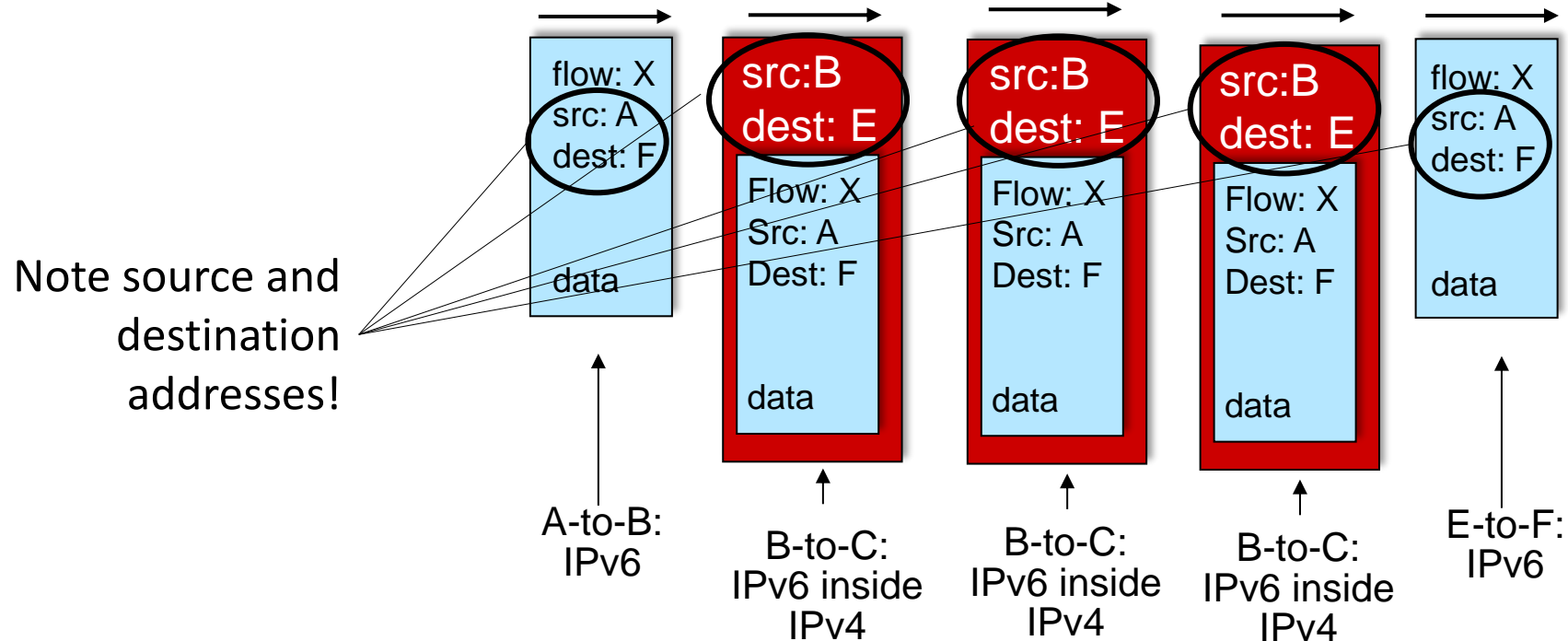
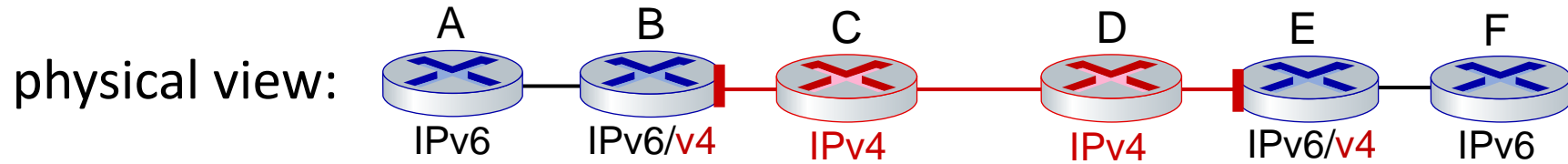
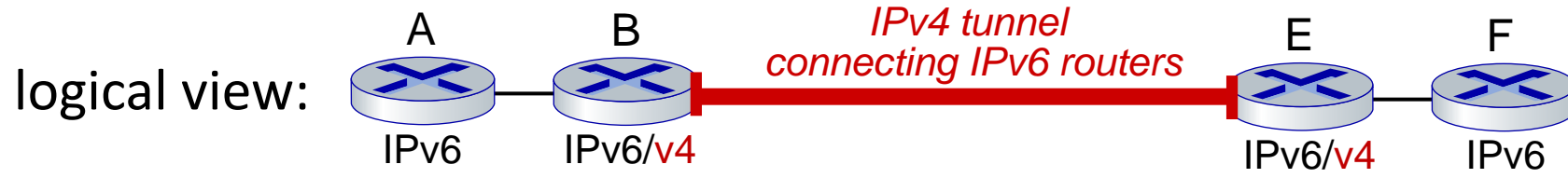

IPv6 adoption

- Google¹: ~ 50% of clients access services via IPv6 (2024)
- NIST: 1/3 of all US government domains are IPv6 capable

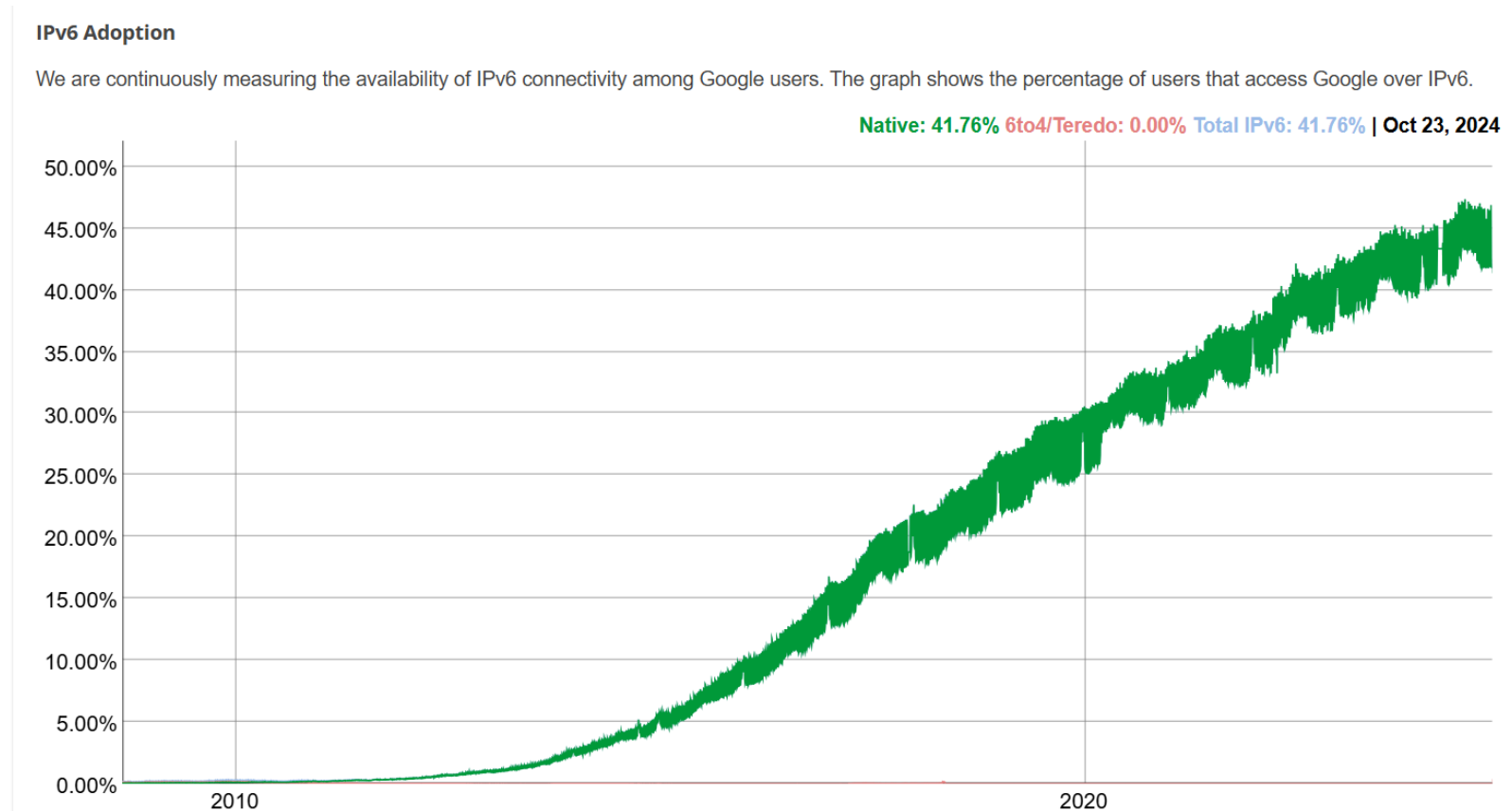

IP addressing: last words ...

Q: how does an ISP get block of addresses?

A: **ICANN:** Internet Corporation for Assigned Names and Numbers
<http://www.icann.org/>

- allocates IP addresses, through 5 regional registries (RRs) (who may then allocate to local registries)

Q: are there enough 32-bit IP addresses?

- ICANN allocated last chunk of IPv4 addresses to RRs in 2011
- NAT (next) helps IPv4 address space exhaustion
- IPv6 has 128-bit address space

"Who the hell knew how much address space we needed?" Vint Cerf (reflecting on decision to make IPv4 address 32 bits long)